



Technical File

Chapter 4 - Floors

Cement-bonded particleboards
Agglomerated particle board with cement

Office

Av. Infante Dom Henrique 337, 3rd Floor
1800- 210 LISBON, PORTUGAL

Factory

VIROC Portugal S.A.
National Road 10
Km 44.7, Vale da Rosa
2914-519 SETÚBAL, PORTUGAL

In/ investwood

www.investwood.pt

CONTENTS

4. FLOORS	5
4.1 General features	5
4.2 Beam-supported panel	6
4.2.1 Thicknesses	6
4.2.2 Panel thickness tolerances	6
4.2.3 Fasteners	6
4.2.4 Panel layout	6
4.2.5 Screws	7
4.2.6 Adhesive mastic	8
4.2.7 Nails	9
4.2.8 Support structure	10
4.2.9 Special finishes	10
4.2.10 Safety check	11
4.2.11 Example of safety check, uniformly distributed loads	12
4.2.12 Example of safety check, concentrated overload (knife load)	13
4.3 Panel resting on continuous support	14
4.3.1 Thickness	14
4.3.2 Thickness tolerances	14
4.3.3 Support structure	14
4.3.4 Fasteners	14
4.4 Surface treatment	15
4.5 Varnish or paint to be used	15
4.6 Joints between panels	16
4.7 Panel edges	16

INDEX TO TABLES AND FIGURES

Figure 4.1 - Viroc floor supported on beams	6
Figure 4.2 - Arrangement of panels, supported on beams	7
Figure 4.3 - Location of the fixings	7
Figure 4.4 - Galvanised steel screw for wooden structure	8
Figure 4.5 - Galvanised steel screws for metal structure	8
Figure 4.6 - Longitudinal section	8
Figure 4.7 - Detail of joint	8
Figure 4.8 - Panel bonding system with mastic	9
Figure 4.9 - Headless nail	9
Figure 4.10 - Pneumatic nail gun	9
Figure 4.11 - Location of the nails	10
Figure 4.12 - Joint between panels	10
Figure 4.13 - Viroc flooring sustained on continuous support	14
Figure 4.14 - Notched trowel for spreading polyurethane mortar	15
Figure 4.15 - Longitudinal section, Viroc layed with polyurethane mortar	15
Figure 4.16 - Joints between panels, filled with mastic	16
Figure 4.17 - Joints between bevelled machined panels	16

TABLE OF UNIFORMLY DISTRIBUTED LOADS 17

Table 1 - Floor load table	17
----------------------------	----

Credits

Author

Mr José Pinheiro Soares,
suporte.tecnico@investwood.pt

Review

CS Traduções
geral@cstraducoes.pt

Viroc Portugal S.A. reserves the right to modify this document without prior notice.

This Technical File annuls all previous technical documents.

Issue: 15 February 2024

4. FLOORS

Due to their strength, Viroc panels can be used as a support and finishing element for floors, supported on beams or as a covering material for a new or existing floor.

When supported on beams (wooden or metal), the maximum distance between them must not exceed 600 mm.

The support of a roof supported on beams with Viroc panels must meet the same requirements as a floor.

It is the installer's responsibility to check the security conditions of the support structure, in particular the distance between the supports and the width of the supports for correct installation of the panels.

Viroc panels undergo small dimensional variations with changes in relative humidity and temperature surrounding. The Viroc panel can be expected to accommodate a maximum dimensional variation of -0.1% (shrinkage) to +0.05% (expansion) in an interior application.

4.1 General features

Application

Interior

Maximum panel size

3000x1250 mm

Any intermediate dimensions obtained by cutting the standard dimension panel are possible.

Cutting tolerances

Length and width: ± 3 mm

Squaring: ≤ 2 mm/m

Edge straightness: ≤ 1.5 mm/m

4.2 Beam-supported panel



Figure 4.1 - Viroc floor supported on beams

4.2.1 Thicknesses

19, 22, 25, 28 and 32 mm

4.2.2 Panel thickness tolerances

± 1.5 mm

4.2.3 Fasteners

Depending on the type of structure, the panels can be fixed with screws, nails, and rivets or glued with polyurethane adhesives (PU mastic).

4.2.4 Panel layout

The panels must be arranged so that the joints are misaligned, as shown in figure 4.2.

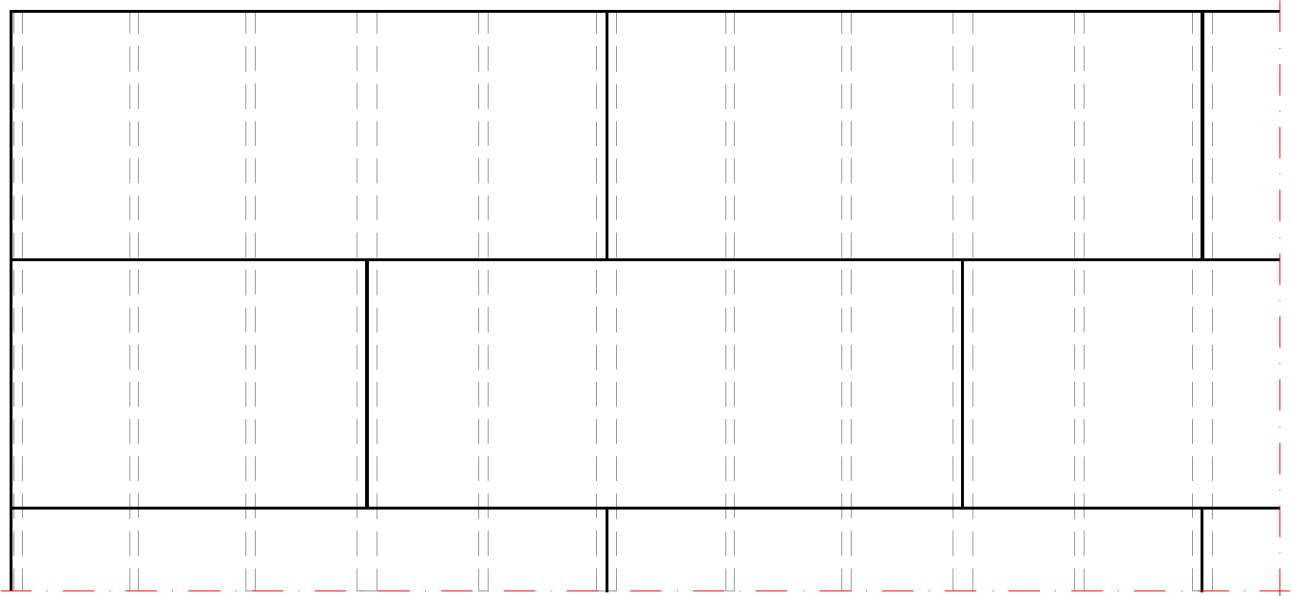

Figure 4.2 - Arrangement of panels, supported on beams

4.2.5 Screws

When fixing the panels with screws, the distances must be taken into account as shown in figure 4.3.

A screw placed too close to the edges can cause the panel to break.

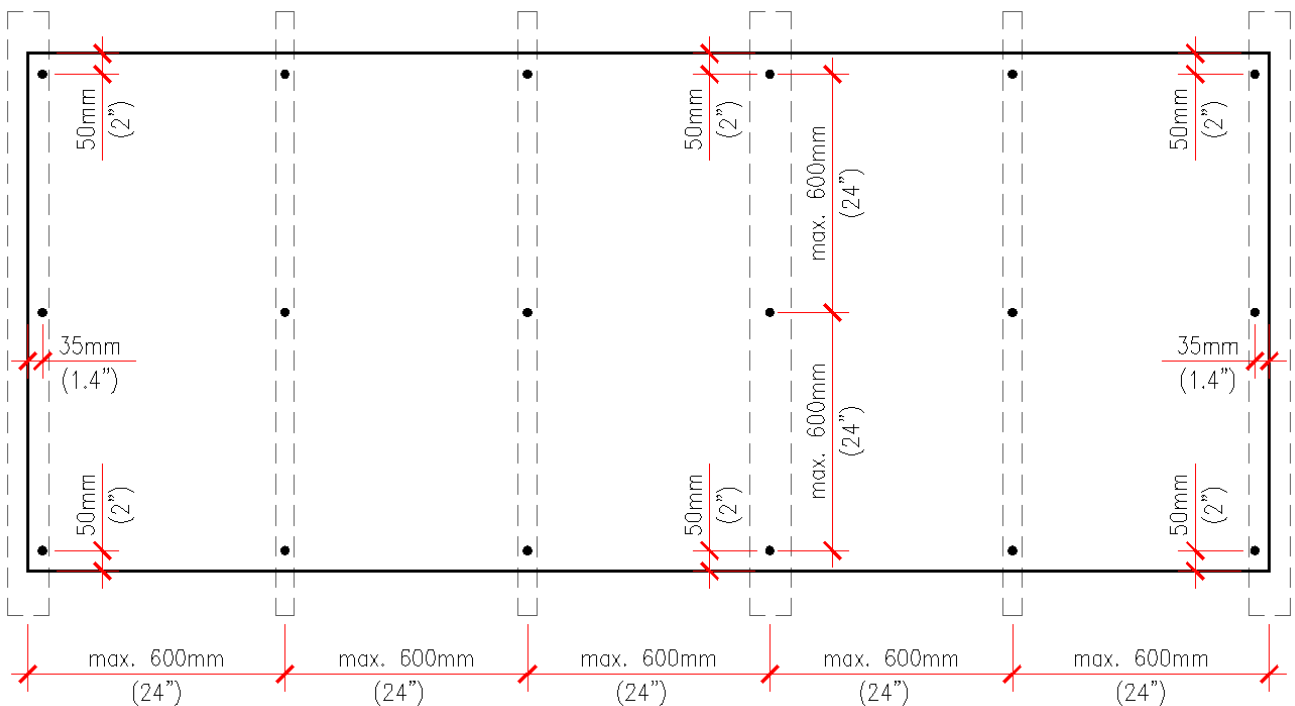

Figure 4.3 - Location of the fixings

Screws for wooden structures must have an anchoring length (depth driven into the wood) of at least 30 mm (see figure 4.4).

When the support structure is made of metal, in addition to the appropriate length of the screw body, the drill tip must be of an appropriate size to pierce the thickness of the metal it will be fixed to (see figure 4.5).

The maximum distance between screws must not exceed 600 mm.

SFS Intec and ETANCO have suitable screws. Screws from other manufacturers can be used as long as they have the same performance.



Figure 4.4 - Galvanised steel screw for wooden structure



Figure 4.5 - Galvanised steel screws for metal structure

4.2.6 Adhesive mastic

Mastic bonding systems can be used to bond Viroc panels to wooden and metal structures.

This type of fixing consists of:

- Adhesion primer for the support structure;
- Adhesion primer for the Viroc panel;
- Double-sided adhesive tape;
- Mastic adhesive.

The adhesive tape is 3 mm thick and its function is to fix the panels while the mastic adhesive is fresh, i.e. without resistance. This ensures that the strand is 3 mm thick without being crushed (see figures 4.6 and 4.7).

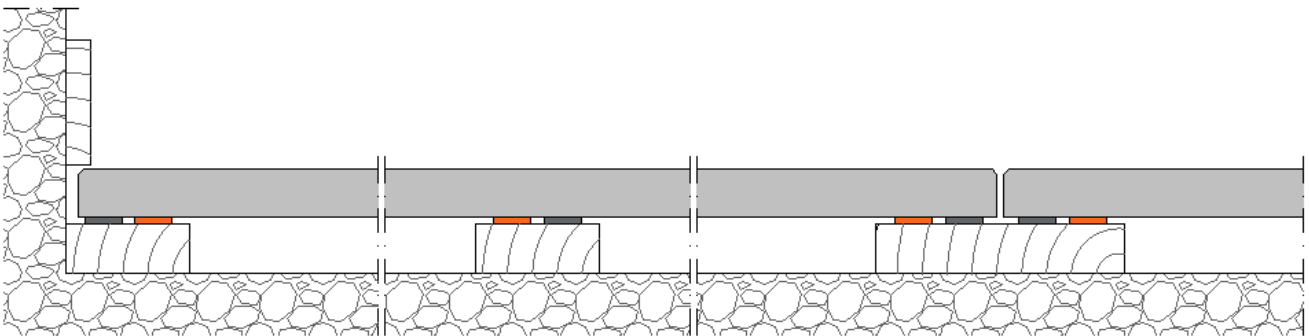

Figure 4.6 - Longitudinal section

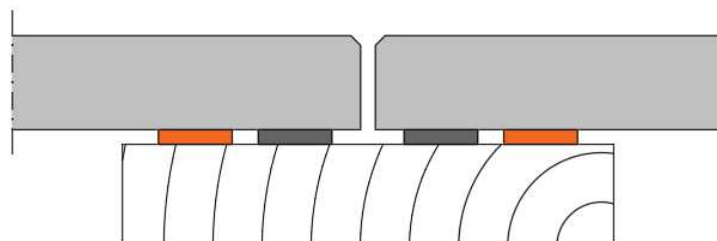

Figure 4.7 - Detail of joint

- Double-sided adhesive tape
- Mastic Adhesive

Sika and Bostik have systems suitable for this application. The manufacturers of these materials should always be consulted for advice and correct application (see figure 4.8).



Figure 4.8 - Panel bonding system with mastic

4.2.7 Nails

If the structure is made of wood, galvanised steel or stainless steel nails can be used to fix the panels to the structure.

There are headless nails that are practically invisible (see figure 4.9).

The nails should be applied using a suitable pneumatic gun (see figure 4.10). Before the final fixing of the panels begins, a series of tests must be carried out to set the right pressure and force for the nails to be driven in correctly.

When fixing with nails, the distances between fixings must not exceed 600 mm in the horizontal direction and 400 mm in the vertical direction (see figure 4.11).



Figure 4.9 - Headless nail



Figure 4.10 - Pneumatic nail gun

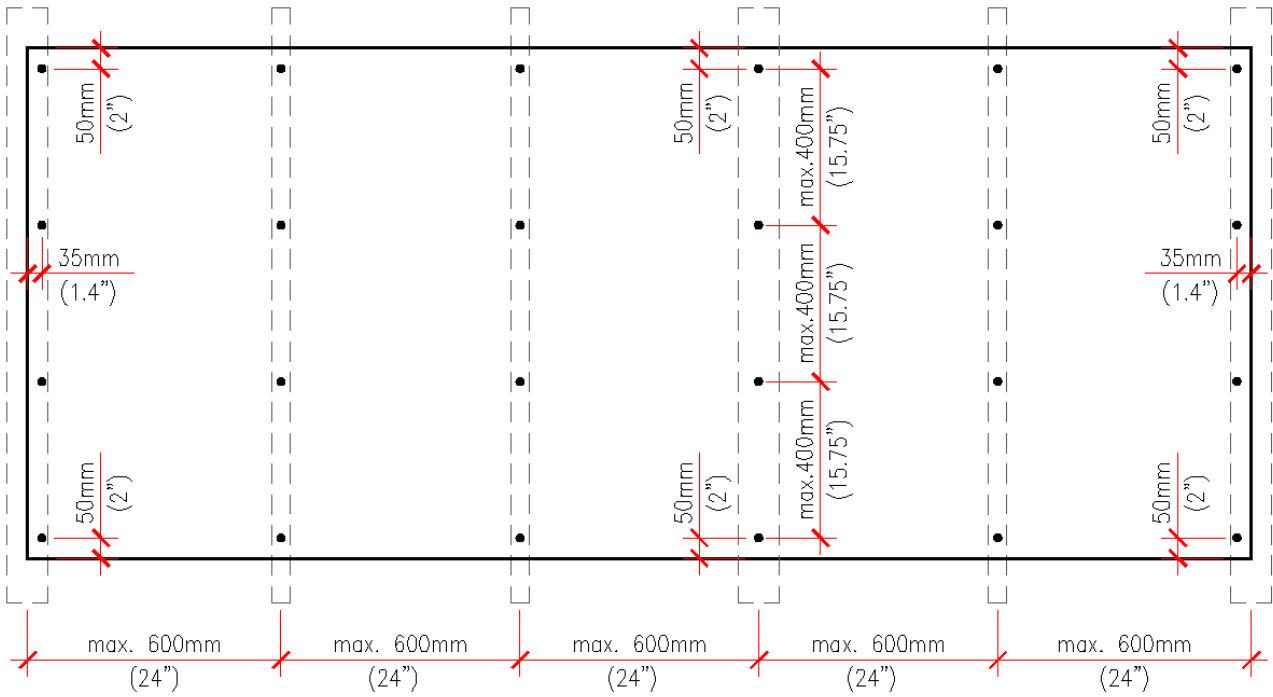

Figure 4.11 - Location of the nails

4.2.8 Support structure

Viroc panels can be supported on a wooden or metal frame. The panels must be positioned so that their longitudinal length is perpendicular to the orientation of the support structure. The structure that will support the Viroc panels must be aligned and properly levelled.

The support structure must be wide enough to allow the fixings to be positioned correctly, respecting the minimum distances between the screws and the edge of the panels, and have the capacity to absorb small positioning errors (see figure 4.12).

The maximum distance between the axes of the support elements (spans) must be 600 mm. Their alignment between adjacent elements must be checked and should not differ by more than 5 mm.

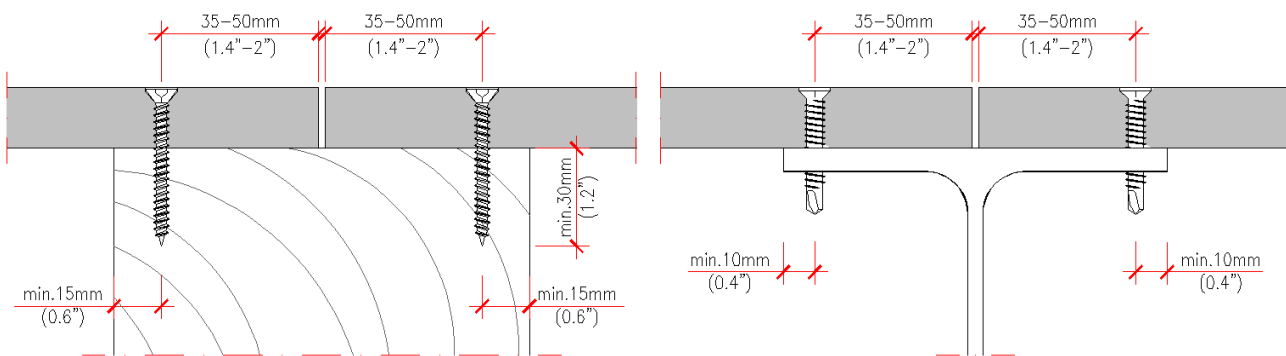

Figure 4.12 - Joint between panels

4.2.9 Special finishes

Floors made with Viroc panels can be finished with wood coverings such as Lamparquet, parquet and parquet flooring or a ceramic finish.

The materials used to glue these types of finishes have to be suitable for the dimensional variations that the panel has, and they need to be very elastic. Polyurethane adhesives have been widely used because of their good adhesion to the Viroc panel and their great elasticity.

The manufacturers of these adhesives should always be consulted for advice and correct application.

4.2.10 Safety check

The safety check of a Viroc panel is carried out in accordance with the requirements of the Eurocode 1 and 5, taking into account the National Application Documents (RSA).

The following values must be adopted when verifying Security to Ultimate Strength Limit States:

- Specific weight (γ), 13.5 kN/m³;
- Density (ρ), 1350 Kg/m³;
- Characteristic flexural tensile strength ($f_{m,k}$), 9.0 MPa;
- Characteristic shear stress ($f_{v,k}$), 1.0 MPa;
- Partial Coefficient of Security (γ_M), 1.3
- Modification factor (k_{mod})
 - Permanent actions, $k_{mod} = 0.30$
 - Long-term actions, $k_{mod} = 0.45$
 - Medium-term actions, $k_{mod} = 0.65$
 - Short-term actions, $k_{mod} = 0.85$

$$M_{Rd} = k_{mod} \cdot W \cdot f_{m,k} / \gamma_M ; V_{Rd} = k_{mod} \cdot A_v \cdot f_{v,k} / \gamma_M$$

The following values must be adopted when checking Safety at Deformation Limit States:

- Modulus of Elasticity (E_m), 4500 MPa;
- Deformation factor (k_{def}), 2.25
- Long term deformation, $\delta_{\infty} = \delta_{instant} \times (1+k_{def})$

The deformation of the panels must not jeopardise the normal functioning of the floors. The maximum deformation due to permanent loads and overloads must not exceed the limit of L/250 of the span between the support fixings.

Examples of the safety check can be found in chapters 4.2.11 and 4.2.12.

Table 1 shows a Load Table for a quick safety check on floors.

4.2.11 Example of safety check, uniformly distributed loads

Dimensioning a floor for a house made of 25 mm thick Viroc panels 2.40 m long, with supports every 60 cm.

Actions

Permanent loads	
Self-weight (Pp)	0.34 kN/m ²
Remaining permanent loads (RCp)	2.00 kN/m ²
Overloads	
Housing (Sc)	2.00 kN/m ²
Concentrated load (knife load)	1.50 kN/m

Uniformly Distributed Loads

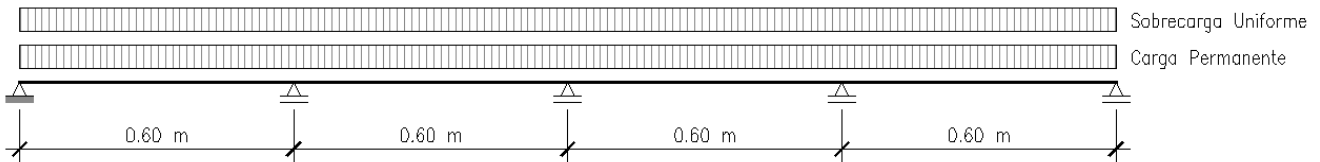

Ultimate Limit State Safety Check

Combination of actions with overload as basic variable action

$$S_{sd} = 1.35 Pp + 1.50 RCp + 1.50 Sc$$

$$k_{mod} = 0.65 \text{ Medium-term actions}$$

Maximum Efforts

$$M_{Sd,max} = 0.24 \text{ kNm/m}$$

$$M_{Rd} = k_{mod} \cdot w \cdot f_{m,k} / \gamma_M = 0.65 \times (25/1000)^2 / 6 \times 9000 / 1.3 = 0.47 \text{ kN/m} > 0.24 \text{ kNm/m}$$

$$V_{sd,max} = 2.35 \text{ kN/m}$$

$$V_{Rd} = k_{mod} \cdot A_v \cdot f_{v,k} / \gamma_M = 0.65 \times 5 / 6 \times (25/1000) \times 1000 / 1.3 = 10.4 \text{ kN/m} > 2.35 \text{ kN/m}$$

Safety check at Deformation Limit States

Quasi-permanent combination of actions

Long-term deformation

$$\delta_{\infty} = \delta_{inst} \times (1 + k_{Def})$$

$$\delta_{inst} = 1.0 \delta_{Pp} + 1.0 \delta_{RCp} + \psi_2 \delta_{Sc} ; (\psi_2 = 0.2)$$

Maximum deformation $L/250$, $600/250 = 2.4 \text{ mm}$

Maximum instantaneous deformation $\delta_{inst} = 0.4 \text{ mm}$

Long-term deformation, $\delta_{rin} = \delta_{inst} \times (1 + 2.25) = 1.3 \text{ mm} < 2.4 \text{ mm}$

4.2.12 Example of safety check, concentrated overload (knife load)

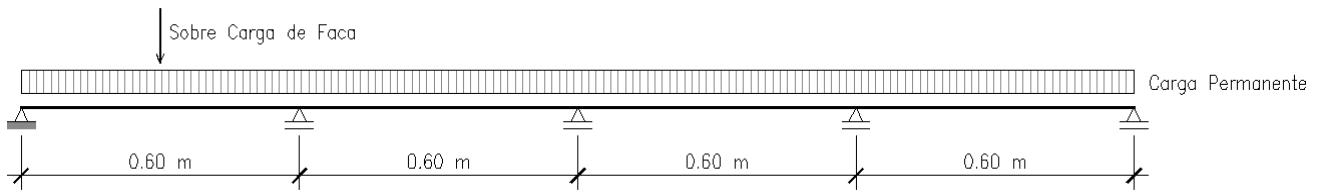

Ultimate Limit State Safety Check

Combination of actions with overload as basic variable action

$$S_{sd} = 1.35 P_p + 1.5 R_{Cp} + 1.5 S_c$$

$$k_{mod} = 0.85 - \text{Short-term actions}$$

Maximum Efforts

$$M_{Sd,max} = 0.37 \text{ kNm/m}$$

$$M_{Rd} = k_{mod} \cdot w \cdot f_{m,k} / \gamma_M = 0.85 \times (25/1000)^2 / 6 \cdot 9000 / 1.3 = 0.61 \text{ kN/m} > 0.37 \text{ kNm/m}$$

$$V_{sd,max} = 2.36 \text{ kN/m}$$

$$V_{Rd} = k_{mod} \cdot A_v \cdot f_{v,k} / \gamma_M = 0.85 \times 5 / 6 \times (25/1000) \times 1000 / 1.3 = 13.62 \text{ kN/m} > 2.36 \text{ kN/m}$$

Safety check at Deformation Limit States

Characteristic combination of actions

Instantaneous deformation

$$\delta_{inst} = 1.0 \delta_{Pp} + 1.0 \delta_{RCp} + \psi_0 \delta_{Sc} ; (\psi_0 = 0.4)$$

$$\text{Maximum deformation } L/250, 600/250 = 2.4 \text{ mm}$$

$$\text{Maximum instantaneous deformation } \delta_{inst} = 0.7 \text{ mm} < 2.4 \text{ mm}$$

Note: A concentrated point overload requires software to calculate the stresses, but the entire safety checking process is similar.

4.3 Panel resting on continuous support



Figure 4.13 - Viroc flooring sustained on continuous support

4.3.1 Thickness

12 mm

4.3.2 Thickness tolerances

± 1 mm

4.3.3 Support structure

Viroc panels can be sustained on a new or existing continuous support. In both situations, the substrate must be levelled and in good condition to support the new coating. Surfaces must be clean of dirt and grease to ensure good adhesion.

4.3.4 Fasteners

The panels are fixed to the substrate with an elastic polyurethane mortar, spread over the entire surface continuously with a notched trowel (see figures 4.13, 4.14 and 4.15).

Sika, Bostik and Mapei have mortars suitable for this application. Mortars from other manufacturers can be used as long as they ensure the right performance.

The manufacturers of these materials should always be consulted for advice and correct application.



Figure 4.14 - Notched trowel for spreading polyurethane mortar

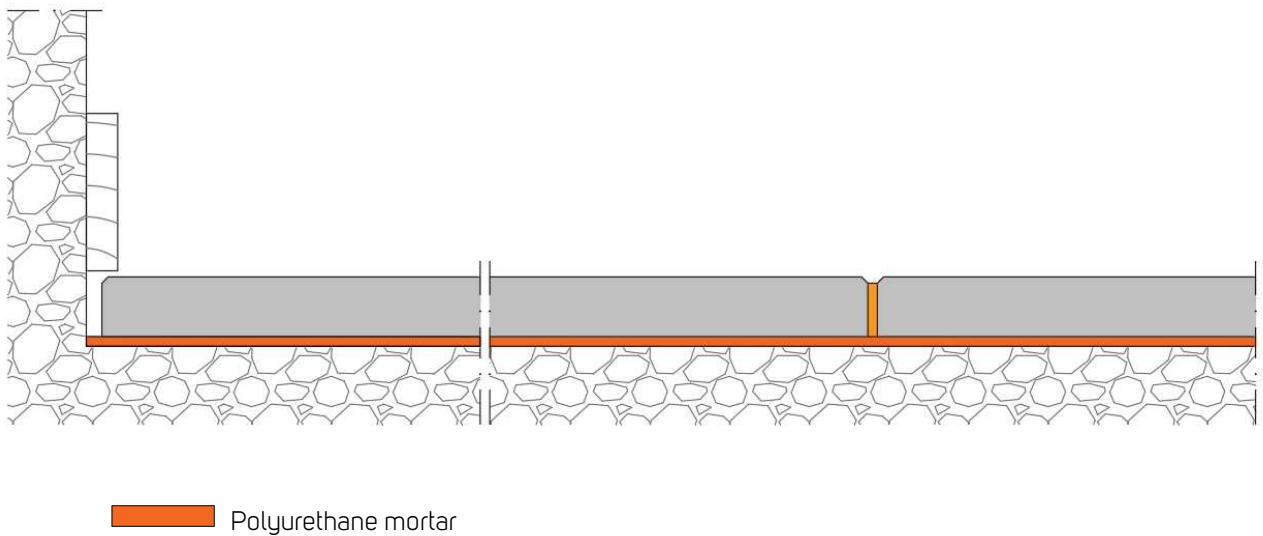

Figure 4.15 - Longitudinal section, Viroc layed with polyurethane mortar

4.4 Surface treatment

The panels must be protected with scratch-resistant paint or varnish suitable for flooring.

Before applying the varnish to the panels, the surface must be completely clean and dry, with no grease, dust or salts. Cleaning can be done by polishing with cleaning disks. VIROC Portugal has suitable disks, which it can supply on request. Alternatively, the surfaces can be cleaned using sandpaper with a fine-grained disk equal to or greater than 120.

4.5 Varnish or paint to be used

The purpose of applying varnish to the Viroc panel is to protect it from the aggressions of use, increasing its durability, making it easier to clean and maintaining its appearance over time.

The application of a varnish can alter the natural colour tone of the Viroc panel, giving it a "wet" appearance with some shine. There are no specific paints or varnishes to be applied to Viroc. The panel has a surface alkalinity (PH) of 11 to 13, so paints and varnishes suitable for concrete and wood surfaces at the same time are usually the best when applied to Viroc panel.

Paints and varnishes made from acrylic resins or solvent-based aliphatic polyurethanes are the ones that have shown the best performance. Water-based acrylic resin or aliphatic polyurethane varnishes have the least effect on the panel original

colour. In addition to the above, paints and varnishes must be suitable for their intended purpose and have the hardness and resistance required for use on floors.

Generally speaking, varnishes are easy to apply, but it is very important to bear in mind that the application must be continuous and constant, to guarantee the homogeneity of the finish on the panel and so that the surface doesn't become stained and have different shades. Panels must always be painted/varnished on both sides and tops, except in the conditions described in 4.3 where the adhesive to the substrate must be applied directly to the panel. The application procedures for paints and varnishes must always be followed applying the coats recommended by the manufacturers.

4.6 Joints between panels

The joints between panels should have a gap of 2 to 3 mm and can be filled with a bead of silicone or mastic (see figure 4.16).

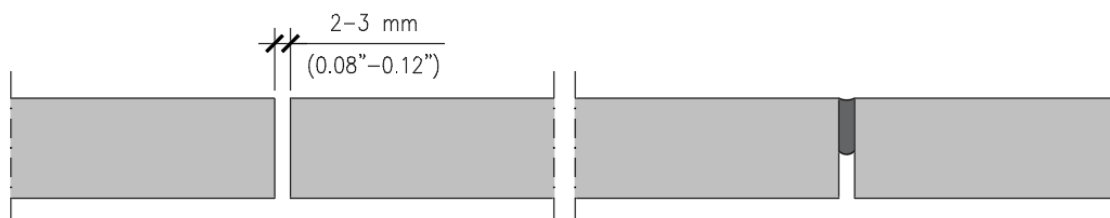

Figure 4.16 - Joints between panels, filled with mastic

4.7 Panel edges

The edges of the panels must be machined in a bevel shape of 2 to 3 mm (see figure 4.17); otherwise the differences in thickness due to the manufacturing tolerance will be visible and will break with use.

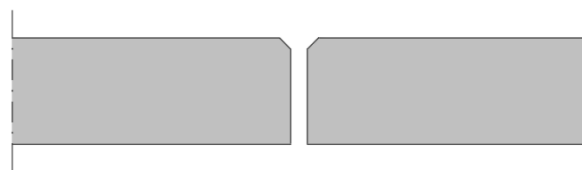

Figure 4.17 - Joints between bevelled machined panels

TABLE OF UNIFORMLY DISTRIBUTED LOADS

Flexural breaking stress: 9 MPa

Modulus of Elasticity: 4500 MPa

Coefficient of Security: 3

2 Supports

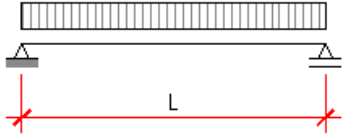

3 Supports

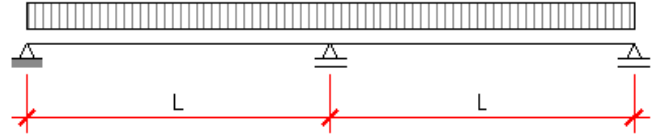

Multiple Supports (>3)

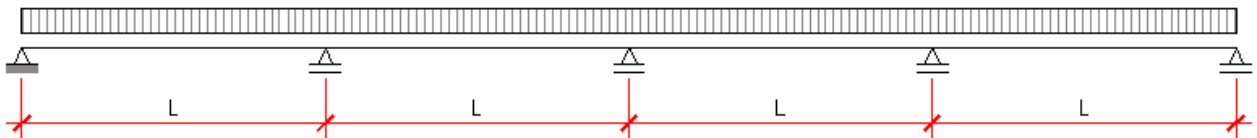

Thickness panel		Span (L)		2 or 3 Supports				Multiple Supports			
mm	polg.	m	polg.	Max. load		L/250		Max. load		L/250	
				kN/m ²	psf	kN/m ²	psf	kN/m ²	psf	kN/m ²	psf
19	3/4	0,3	12	15,8	330	15,8	330	18,5	386	18,5	386
		0,4	16	8,8	183	8,8	183	10,3	215	10,3	215
		0,5	20	5,5	115	5,5	115	6,5	136	6,5	136
		0,6	24	3,8	78	3,4	71	4,4	93	4,4	93
22	7/8	0,3	12	21,2	443	21,2	443	24,8	519	24,8	519
		0,4	16	11,8	247	11,8	247	13,8	289	13,8	289
		0,5	20	7,4	156	7,4	156	8,7	183	8,7	183
		0,6	24	5,1	106	5,1	106	6,0	125	6,0	125
25	1	0,3	12	27,4	573	27,4	573	32,1	671	32,1	671
		0,4	16	15,3	319	15,3	319	17,9	374	17,9	374
		0,5	20	9,7	202	9,7	202	11,3	237	11,3	237
		0,6	24	6,6	138	6,6	138	7,8	162	7,8	162
28	1 1/8	0,3	12	34,5	720	34,5	720	40,3	842	40,3	842
		0,4	16	19,2	401	19,2	401	22,5	470	22,5	470
		0,5	20	12,2	254	12,2	254	14,3	298	14,3	298
		0,6	24	8,3	174	8,3	174	9,8	205	9,8	205
32	1 1/4	0,3	12	45,1	941	45,1	941	52,7	1101	52,7	1101
		0,4	16	25,2	526	25,2	526	29,5	616	29,5	616
		0,5	20	16,0	333	16,0	333	18,7	391	18,7	391
		0,6	24	10,9	229	10,9	229	12,9	269	12,9	269

Table 1 - Floor load table