

Fachadas Ventiladas con paneles Viroc - Estructura de Aluminio

Tornillos y remaches para la fijación de paneles Viroc

Paneles de 12 mm de espesor

SX3/15-L12-S16-5.5x32

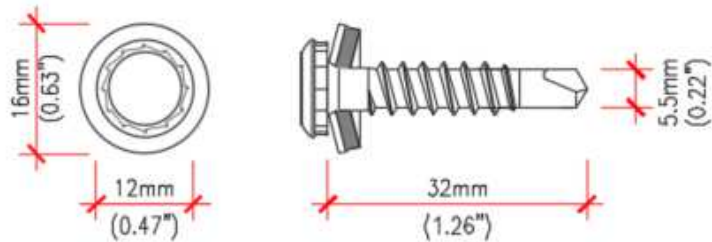

Application

Stainless steel fastening of steel / aluminium sheet or façade panels to steel or aluminium structure in one operation: drilling, thread forming and sealing.

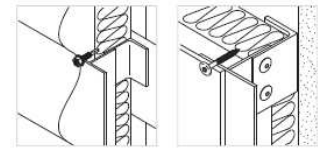
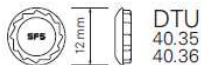

Product code	article number	VD	KL	d x L	PU	notes
SX3/15-L12-S16/1-5,5X32	1403191	3	15	5,5X32	250	

SX3/15-D16-5,5x30

Application

Stainless steel fastening of steel / aluminium sheet or façade panels to steel or aluminium structure in one operation: drilling, thread forming and sealing.

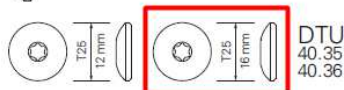
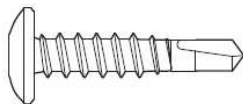

Product code	article number	VD	KL	d x L	PU	notes
SX3/15-D12-5,5X30	1403193	3	15	5,5X30	250	
SX3/15-D16-5,5X30	1270106	3	15	5,5X30	250	

Remaches AP16-S-5.0x21

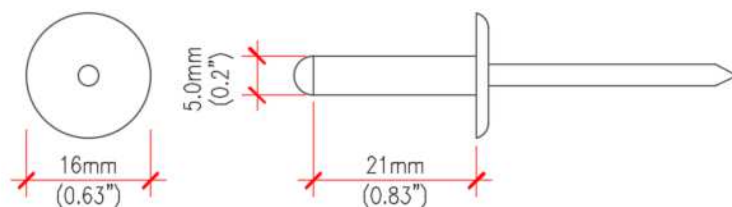

Accesorio: Nosepiece (uso obligatorio)

Paneles de 16 mm de espesor

SX5-L12-S16-5.5x41

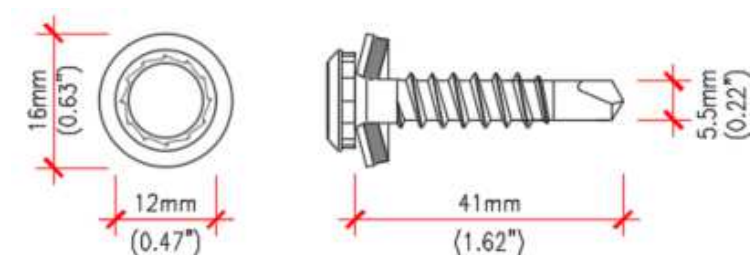

Remaches SSO-D15-5x22

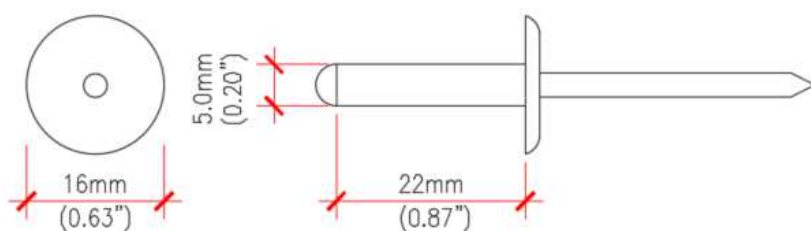

Accesorio: Nosepiece (uso obligatorio)

Estructura de soporte

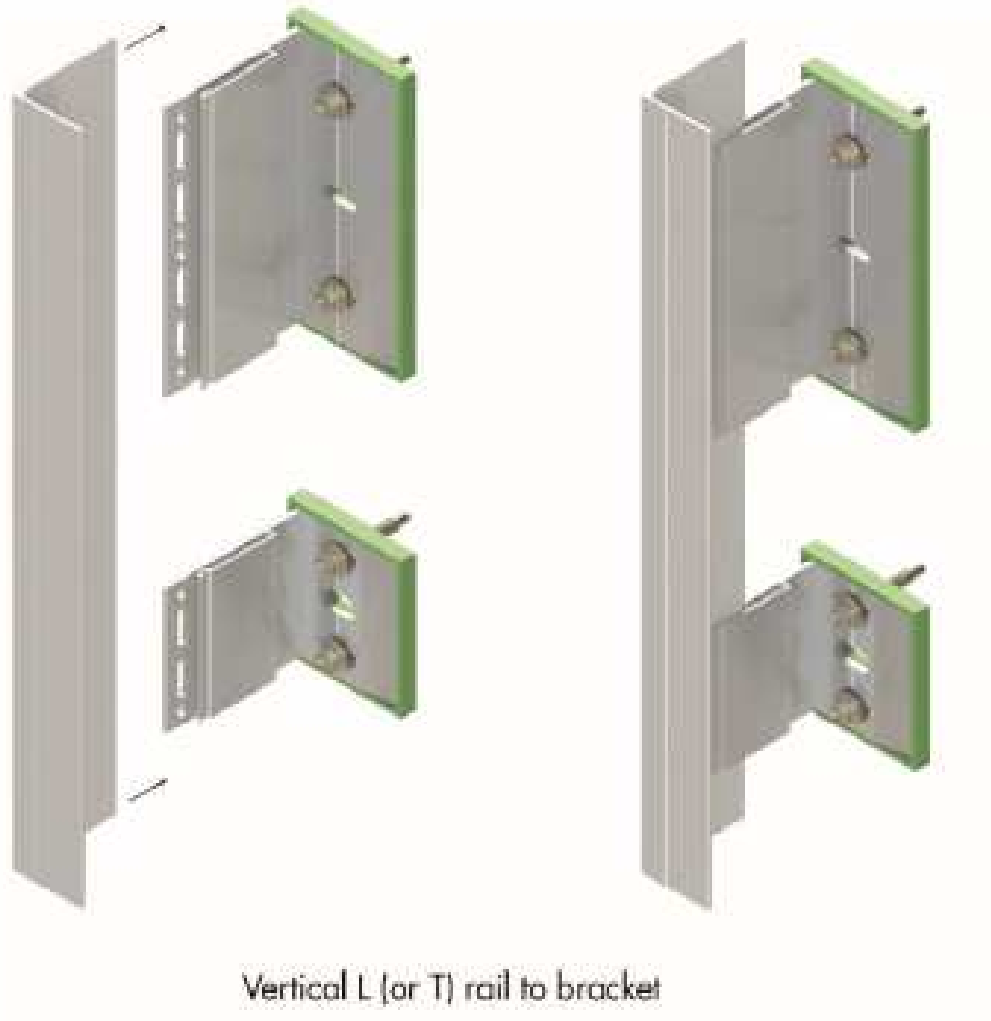

Escuadros

Table 1 Aluminium NV Bracket — single (75 mm) — design resistances (for bracket out-stand leg)

Bracket leg length (A) ⁽¹⁾ (mm)	Projection range ⁽²⁾ (mm)	Code	Design resistance (kN) ⁽³⁾⁽⁴⁾	
			Vertical (shear)	Horizontal (axial)
40	47 – 67	NV-VB040S	2.45	2.68
60	62 – 102	NV-VB060S	1.34	1.92
90	92 – 132	NV-VB090S	1.11	1.47
120	122 – 162	NV-VB120S	0.98 ⁽⁵⁾	1.11 ⁽⁵⁾
150	152 – 192	NV-VB150S	0.84 ⁽⁵⁾	0.89 ⁽⁵⁾
180	182 – 222	NV-VB180S	0.67	0.71 ⁽⁵⁾
210	212 – 252	NV-VB210S	0.54	0.62
240	242 – 282	NV-VB240S	0.45	0.58
270	272 – 312	NV-VB270S	0.36	0.54 ⁽⁴⁾
300	302 – 342	NV-VB300S	0.22	0.49

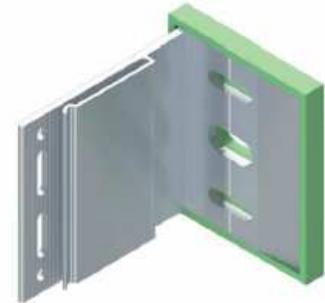

Table 2 Aluminium NV Bracket — double (150 mm) — design resistances (for bracket out-stand leg)

Bracket leg length (A) ⁽¹⁾ (mm)	Projection range ⁽²⁾ (mm)	Code ⁽³⁾	Design resistance (kN) ⁽⁴⁾⁽⁵⁾	
			Vertical (shear)	Horizontal (axial)
40	47 – 67	NV-VB040D	3.57	4.01
60	62 – 102	NV-VB060D	3.34	2.90
90	92 – 132	NV-VB090D	2.68	2.50
120	122 – 162	NV-VB120D	1.03 ⁽⁶⁾	2.31 ⁽⁶⁾
150	152 – 192	NV-VB150D	1.21 ⁽⁶⁾	2.10 ⁽⁶⁾
180	182 – 222	NV-VB180D	0.79 ⁽⁶⁾	1.78
210	212 – 252	NV-VB210D	0.66 ⁽⁶⁾	1.47
240	242 – 282	NV-VB240D	0.58 ⁽⁶⁾	1.29
270	272 – 312	NV-VB270D	0.48 ⁽⁶⁾	1.16
300	302 – 342	NV-VB300D	0.45 ⁽⁶⁾	1.03



Anclaje (escuadras-soporte)

SXR-10-80-FUS-A (1 un/escuadra)



Perfiles L e T de aluminio

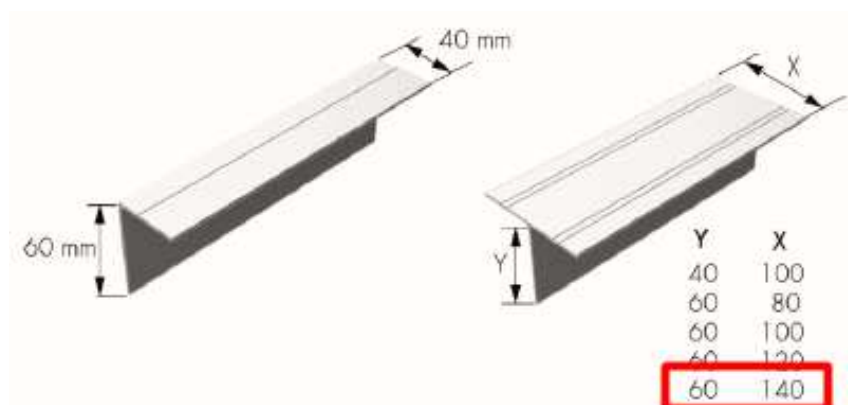

Type	Dimensions	Material number
L Profile	60 x 40 x 2.2 x 3000	1521357
L Profile	60 x 40 x 2.2 x 3600	1521365
L Profile	60 x 40 x 2.2 x 4850	1521370
L Profile	60 x 40 x 2.2 x 6000	1521375
T Profile	40 x 100 x 2.2 x 3000	1521413
T Profile	40 x 100 x 2.2 x 6000	1521417
T Profile	60 x 100 x 2.2 x 3000	1521423
T Profile	60 x 100 x 2.2 x 4850	1521431
T Profile	60 x 100 x 2.2 x 6000	1521434
T Profile	60 x 140 x 2.2 x 3000	1521445
T Profile	60 x 140 x 2.2 x 6000	1521447

Tornillos (escuadra-perfil)

SDA5/5.5x22, (2 un/escuadra)



Remache (escuadra-perfil), alternativa

ASO-D11-5x12, (2 Un/escuadra)

Anclaje plástico (aislamiento-suporte)



		Order code						
		MDH-	8,0x	60				
Applications	Product	Type	d	L	SD	Application range		
	<p>● Plastic</p>	MDH-	8,0x	60	20	 1. Drill a pilot hole 2. Set plug until head lies flush on insulation 3. Use a hammer for installation 4. MDH has to be hammered precisely onto insulation		
		MDH-	8,0x	80	20			
		MDH-	8,0x	100	20			
		MDH-	8,0x	120	20			
		MDH-	8,0x	140	20			
		MDH-	8,0x	160	20			
		MDH-	8,0x	180*	30			
		MDH-	8,0x	200*	30			
		MDH-	8,0x	220*	30			
		MDH-	8,0x	240*	30			
				* two pieces				

Accesorios

Chave E420 tornillos de cabeza irius.



Nosepiece, Limitador de apriete de remaches



Centrador de furos para remaches



d diameter | L Length | f flute length | t thickness of structure | All measures in mm

Example order code

DG- 146x20 7,0

Type	L	Nose	Application range
DG-	146x20-	7,0	<p>Can be used with all cordless screw drivers available on the market.</p>
DG-	146x20-	8,0	
DG-	146x20-	9,0	
DG-	146x20-	10,0	

Llave para centrar tornillos con diámetro de 5,5 mm, ZL-SX/SD-5.5/8.0



Llave para centrar agujeros con diámetro de 5,1 mm, ZL-5.1/7-18



Perfil angular, auxiliar

		PFS-K-A- 10/10				
Application	Product	Type	axb	KL	Application range	
	▲ Aluminium	PFS-K-A- 10/10		≤ 10	Length of the profile: L = 2,8 m Thickness: e = 0,8 mm	
		PFS-K-A- 18/18		≤ 18		
		PFS-K-A- 29/29		≤ 29		
		PFS-K-A- 40/40		≤ 40		

PFS-K-Aluminium



		PFS-Q-A- 10/10				
Application	Product	Type	axb	KL	Application range	
	▲ Aluminium	PFS-Q-A- 10/10		≤ 10	Length of the profile: L = 2,8 m Thickness: e = 0,8 mm	
		PFS-Q-A- 18/18		≤ 18		

PFS-Q-Aluminium



		PFR-A- 10/10				
Application	Product	Type	axb	KL	Application range	
	▲ Aluminium	PFR-A- 10/10		≤ 10	Length of the profile: L = 2,8 m Thickness: e = 0,8 mm	
		PFR-A- 15/15		≤ 15		
		PFR-A- 18/18		≤ 18		

PFR-Aluminium



Perfiles anti-roedores

PV-Aluminium



		PV-A- 30x30				
Application	Product	Type	hxl	KL	Application range	
	▲ Aluminium	PV-A- 30x30			Length of the profile: L = 2,5 m Thickness: e = 0,8 mm	
		PV-A- 30x40				
		PV-A- 30x50				
		PV-A- 30x60				
		PV-A- 30x70				
		PV-A- 30x90				
		PV-A- 40x100				
		PV-A- 40x120				
		PV-A- 40x140				
		PV-A- 40x160				
		PV-A- 40x180				
		PV-A- 40x200				
		PV-A- 40x220				
		PV-A- 40x240				
		PV-A- 40x260				
		PV-A- 40x280				
		PV-A- 40x300				



Contactos para información y suministro

España

T: +34 946 333 120

E: es.info@sfs.com

Portugal

T: +351 219 669 840

E: pt.info@sfs.com

Francia

T: +33 4 75 75 44 22

E: fr.info@sfs.com

UK

T: +44 (0) 330 0555 888

E: ukenquiries@sfs.com

USA

T: +1 610 376 5751

E: us.construction@sfs.com

Canadá

T: +1 905 847 5400

E: ca.info@sfs.com

Norway

T: +47 67 92 14 40

E: no.info@sfs.com

Sweden

T: +46 152 71 50 00

E: se.info@sfs.com

Finland

T: +358 9 3154 9810

E: fi.info@sfs.com

Nederland

T: +31 492 597 414

E: bnl.info@sfs.com

Polnad

T: +48 61 660 49 00

E: pl.info@sfs.com

Italy

T: +39 0434 995 1

E: it.info@sfs.com

Germany

T: +49 6171 700 20

E: de.info@sfs.com

Czech Republic

T: +420 481 354 4111

E: cz.construction@sfs.com

Estonia

T: +372 6610 600

E: ee.info@sfs.com